

Application

(post deadline)

Natick Affordable Housing Program

Natick, MA

The deadline for entrance into the lottery has already passed. Eligible Households will now be added to the bottom of the appropriate Unit Selection Lists in the order that their completed applications are received. Please read the Info Packet for more details.

Estimated Sales Prices range from \$112,000 to \$125,000 for a 1 BR, \$125,000 to \$140,000 for a 2 BR and \$172,400 to \$187,200 for a 3 BR. Estimated sales price may vary based on condominium dues (if applicable). Sale Prices do not change based on an applicant's income.

Maximum Household Income Limits: \$46,300 (1 person), \$52,950 (2 people), \$59,550 (3 people), \$66,150 (4 people), \$71,450 (5 people), and \$76,750 (6 people)

There are no MINIMUM Household Income Requirements but households must submit mortgage pre-approvals equal to the sales prices of the unit size(s) for which they apply.

Please read the Information Packet for more details.

Directions:

This application consists of three sections:

Section 1: The Program Application

Section 2: The Required Forms and Documentation Workbook

Section 3: Additional Forms *(if applicable)*

The first two sections must be filled out entirely in order for your application to be processed. If a question does not apply to you, write "N/A" or cross it out. LEAVE NOTHING BLANK.

You must include all income and asset documentation with this application.

You must include mortgage pre-approval with this application.

You must include all *applicable* forms from Section 3 with this application.

Send all completed applications to:

SEB

Re: NATICK GGP

165 Chestnut Hill Ave, Unit 2

Brighton, MA 02135

For Questions call (617) 782-6900 and leave a message.

Section 1

The Program Application

Natick GGP Affordable Housing PROGRAM APPLICATION

Name _____ Home Tel. # _____

Address _____ Work Tel. # _____

City _____ State _____ Zip _____

Email (if available) _____

Unit size(s) for which you are applying (please circle all that apply):

1-Bedroom

2-Bedroom

3-Bedroom

HOUSEHOLD MEMBERS:

Please list **ALL** household members who will occupy the affordable apartment:

Name	Date of Birth	Sex	SS#	Relationship

HOUSEHOLD TYPE (please check one):

- 6 person household: all types
- 5 person household: all types

- 4 person household: all types
- 3 person household: 1 head-of-household plus 2 members
- 3 person household: 2 heads-of-household under criteria c (*see pg. 11 of the Info Packet*) plus 1 member

- 3 person household: 2 heads-of-household plus 1 members
- 2 person household: 2 heads-of-household under criteria c (*see pg. 11 of the Info Packet*)
- 2 person household: 1 head-of-household plus one member

- 2 person household: 2 heads-of-household
- 1 person household: all types

HOMEOWNERSHIP:

Has anyone listed on this application owned a home in the past 3 years or does anyone on this application currently own a home? YES NO

**If you answered NO, please move on to Preference Information on the next page.
If you answered YES, please answer all the following questions.**

To qualify as an **age-qualified household**, please answer the following question about the person that has owned a home in the past 3 years or who currently owns a home:

Are they age 55 or older? YES NO

To qualify as a **displaced homemaker**, please answer the following questions about the person that has owned a home in the past 3 years or currently owns a home:

Are they are an adult? YES NO
Have they owned a home only with a partner? YES NO
While married did they work primarily without remuneration to care for the home or family?
(ex: If they worked full-time while married, you must answer NO) YES NO
Are they currently legally separated from a spouse? YES NO
Has the home in question already been sold? YES NO

If you answered NO to the last two questions you are still eligible for the lottery but you must finalize your separation and/or sell your home before you will be given an opportunity to purchase an affordable unit. Please read the Information Packet for more details.

To qualify as a **single parent**, please answer the following questions:

Do you have 1 or more child of whom you have custody or joint custody, or are you pregnant? YES NO
Did you own a home with your partner or reside in a home owned by your partner? YES NO
Has the home in question already been sold? YES NO
Are you unmarried or legally separated from your spouse? YES NO

If you answered NO to the last two questions you are still eligible for the lottery but you must finalize your separation and/or sell your home before you will be given an opportunity to purchase an affordable unit. Please read the Information Packet for more details.

DATABASE INFORMATION

Local Preference was given for the lottery but as names are now being added to the Lottery Results Lists in the order completed applications are received, there is no Local Preference. These questions are for record keeping purposes.

(please check the appropriate box):

YES

NO

Do you or any member of your household a currently reside within the geographical limits of the Town of Natick?		
Have you or any member of your household been displaced from a residence in the Town of Natick within the previous two (2) years by condominium conversion or by the sale of the person's residence by the property owner?		
Do you or any member of your household have a spouse, son, daughter, father, mother, brother, sister, grandfather or grandmother who currently resides within the geographical limits of the Town of Natick?		
Are you or any member of your household employed by the Town of Natick, including without limitation persons who work for Town of Natick departments and persons who work for the Natick Public Schools?		

You are requested to complete the following optional section in order to assist in determining preference.

(please check all boxes that apply):

	APPLICANT	CO-APPLICANT	DEPENDENT
Black			
Hispanic			
Cape Verdean			
Asian/Pacific Islander			
Eskimo/Aleut			
Native American			
White/Non-Minority			

How did you find out about this affordable housing opportunity?
(write your answer in the space provided and please be as specific as possible)

Instructions for Completing the Following Income Table

- List ALL CURRENT sources of income as requested below for ALL household members over 18 years old.
- Please note that the Income Table is 2 pages and income from Social Security, Pension, interest etc. is all on the second page of the table.
- If you have left a job since January 1, 2009 and are no longer receiving income, do NOT list it in this table.
- For self-employed applicants- include the employer, contract or job name in the space provided.
- For periodic payments (like Social Security and child support) please include the amount received per week or per month (ex: \$100/mo) in the space provided under "Source of Income". Then provide the appropriate amount under "Current GROSS Monthly Income" (ex: \$1,200).
- "Interest Income" refers to any amount that you receive from any asset including amounts that you may be drawing down from a retirement account or 401K.
- For any section that doesn't apply, cross out or write NA.

In Section 2 of this application, you will be asked multiple questions about your information in the following Income and Asset tables.

INCOME

Household Member Name	Source of Income	Current GROSS Monthly Income
	Employer (name)	
	Employer (name)	
	Employer (name)	
	Employer (name)	
	Employer (name)	
	Employer (name)	
	Employer (name)	
	Employer (name)	
	Employer (name)	
	Employer (name)	
	Employer (name)	
	Employer (name)	
	Employer (name)	
	Employer (name)	
	Self-Employed (source name)	
	Self-Employed (source name)	
	Self-Employed (source name)	
	Self-Employed (source name)	
	Child Support/Alimony	
	Child Support/Alimony	
	Periodic payments from family/friends	
	Periodic payments from family/friends	
	Other Income (name/source) (ex: Down Payment Assistance)	
	Other Income (name/source) (ex: Down Payment Assistance)	

Household Member Name	Source of Income	Current GROSS Monthly Income
	Social Security	
	Social Security	
	Social Security	
	Social Security	
	SSDI	
	SSDI	
	Unemployment Compensation	
	Workman's Compensation	
	Severance Pay	
	Pension (list source)	
	Pension (list source)	
	Retirement Funds	
	Title IV/TANF	
	Full-Time Student Income (18 & Over Only)	
	Full-Time Student Income (18 & Over Only)	
	Interest Income (source)	
	Interest Income (source)	
	Interest Income (source)	
	Interest Income (source)	
	Interest Income (source)	
	Interest Income (source)	
	Interest Income (source)	
	Total Gross Monthly Household Income (TGMHI)	\$ /month
TGMHI x 12 =	Anticipated Gross Yearly Household Income	\$ /year

ANTICIPATED CHANGES IN INCOME (please check one)	YES	NO
<p>1. Is your Anticipated Gross Yearly Household Income (written in the last box at the end of the above Income Table) <i>greater than the Allowable Income Limits</i> for a household of your size as specified on the cover page of this Program Application?</p> <p>If YES, please explain why you think your household is still eligible for entrance into this Lottery (<i>ex: upcoming maternity leave, planned change in employment etc.</i>):</p> <p><i>All claims made above must be supported with documentation submitted with this application.</i></p>		
<p>2. Are there any planned changes in income over the next 12 months?</p> <p>If YES, please explain:</p> <p><i>All claims made above must be supported with documentation submitted with this application.</i></p>		

ASSETS

If a section doesn't apply, cross out or write NA. You will need to submit detailed bank/balance statements for EVERY ASSET listed here.

Checking Accounts	Name on Account	Bank	Amount	
			Balance	\$
			Balance	\$
			Balance	\$
Savings Accounts			Balance	\$
			Balance	\$
			Balance	\$
Trust Account			Balance	\$
Certificates (or CDs)			Balance	\$
			Balance	\$
			Balance	\$
			Balance	\$
Savings Bonds	Maturity Date:		Value	\$
	Maturity Date:		Value	\$
401k, IRA, Retirement Accounts (Net Cash Value)	Company Name:		Value	\$
	Company Name:		Value	\$
	Company Name:		Value	\$
	Company Name:		Value	\$
Mutual Funds	Name:	# of Shares:	Interest/Dividends	Value
			\$	\$
			\$	\$
			\$	\$
Stocks			\$	\$
			\$	\$
			\$	\$
Bonds			\$	\$
			\$	\$
Investment Property			Appraised Value	\$

REAL ESTATE

You may only currently own a home if one of your household members is over the age of 55

Do you currently own a home?	<input type="checkbox"/> Yes <input type="checkbox"/> No
Location of property:	\$
Appraised Market Value:	\$
Mortgage or outstanding loans balance due:	\$

Section 2

The Required Forms and Documentation Worksheet

Please answer each of the following 14 questions, attach all requested documentation, complete all applicable forms, and check all applicable boxes.

Every time you answer “YES”, you MUST submit the requested documentation.

If you have not filed your 2009 taxes, you must ALSO provide all tax documentation from 2008 (1040s, 1099s, W-2s etc.)

Only send copies of income/asset documentation.
We do not want originals.

Current Employment Questions

1. Is anyone in your household currently employed?
(NOT including self-employment)

How many of the jobs on page 6 of the Program Application are currently being worked? (NOT including self-employment)

For **every** job listed here you need attach BOTH:

- Copies of the 5 most recent pay-stubs
(If you do not receive pay-stubs you will need to attach a note from the employer on company letterhead stating your tenure and Year To Date amount)
- Attach copies of your 2009 W-2s
(if a job was started after January 1, 2010, write NA)

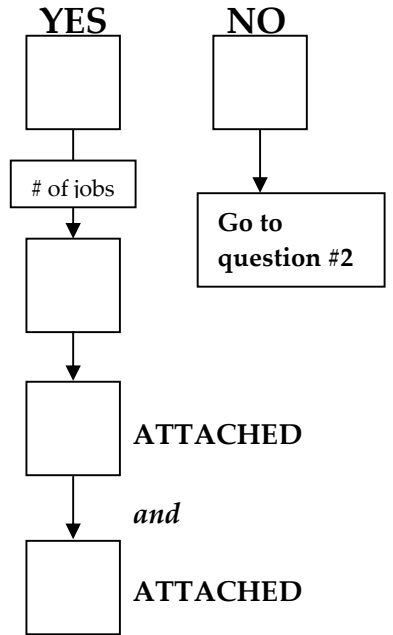

Example of a pay-stub:

Employee Name		SS#	Period End	Check Date	Check No.	Check Amount	
Bbbbbbb.Bbbbbbb B		111-66-7777	10/23/99	11/03/99	208	*****515.40	
Description	Hours	Rate of Pay	Earnings	Deductions	Current	Y-T-D	Leave Balance
Reg Pay	6.00	13.65	81.90	Fed Tax	66.39	1,530.67	
Vacation	28.00	13.65	382.20	FICA SS	40.32	985.59	VACATION 41.24
Ben Bank	1.00	90.08	90.08	FICA Med	9.43	230.50	
Misc	7.00	13.65	95.55	PA ST TX	18.19	445.06	
				Swat Tax	.00	10.00	
Description	Current	Y-T-D					
GROSS PAY	649.73	15,895.44					
TOTAL DEDUCTIONS	134.33						
NET PAY	515.40						

SWARTHMORE COLLEGE - Swarthmore, PA. 19081

Example of a blank W-2 (these are provided by your employer for your taxes):

a Control number		22222	For Official Use Only ▶ OMB No. 1545-0008	
b Employer identification number (EIN)		1 Wages, tips, other compensation		2 Federal income tax withheld
c Employer's name, address, and ZIP code		3 Social security wages	4 Social security tax withheld	
		5 Medicare wages and tips	6 Medicare tax withheld	
		7 Social security tips	8 Allocated tips	
d Employer's social security number		9 Advance EIC payment	10 Dependent care benefits	
e Employer's first name and initial		11 Nonqualified plans		12a See instructions for box 12
Last name		13a Stray income		12b
Suff.		13b Reserve pay		12c
		13c Other		12d
f Employer's address and ZIP code		14 Other		12e
15 State Employer's state ID number		16 State wages, tips, etc.	17 State income tax	18 Local wages, tips, etc.
		19 Local income tax		20 Locally name

Form **W-2** Wage and Tax Statement **2006** Department of the Treasury—Internal Revenue Service
 Copy A For Social Security Administration — Send this entire page with Form W-3 to the Social Security Administration; photocopies are not acceptable. Cat. No. 10134D

Do Not Cut, Fold, or Staple Forms on This Page — Do Not Cut, Fold, or Staple Forms on This Page

Income Questions

2. Did you list any sources of Income on page 8 of this application?
(ie: Social Security, SSDI, Pensions, Unemployment, Public Assistance, TANF, Veteran's Benefits, Retirement, Student Income, Interest Income etc.)

YES

NO

of sources

How many sources of Income did you list on page 8?

Go to question #3

For **every** source of income listed, regardless of the amount of income received (even just \$1), you need to:

- Attach copies of your most recent statements from the source of income.
- Attach copies of your most recent 1099s from the source of income *(if received)*.

If you do not receive statements (i.e. the amounts are direct deposited), please submit 3 months checking account statements and highlight the appropriate deposits.

ATTACHED

Example of a blank 1099:

9595		<input type="checkbox"/> VOID <input type="checkbox"/> CORRECTED		OMB No. 1545-0115	
PAYER'S name, street address, city, state, ZIP code, and telephone no.		1 Rents	\$	2006 Form 1099-MISC Miscellaneous Income	
		2 Royalties	\$	Copy A For Internal Revenue Service Center	
		3 Other income	\$	File with Form 1096.	
PAYER'S federal identification number	RECIPIENT'S identification number	4 Federal income tax withheld	\$	For Privacy Act and Paperwork Reduction Act Notice, see the 2006 General Instructions for Forms 1099, 1098, 5498, and W-2G.	
RECIPIENT'S name		5 Fishing boat proceeds	\$		
Street address (including apt. no.)		6 Medical and health care payments	\$		
City, state, and ZIP code		7 Nonemployee compensation	\$		
Account number (see instructions)	2nd TIN not <input type="checkbox"/>	8 Substitute payments in lieu of dividends or interest	\$		
		9 Payer made direct sales of \$5,000 or more of consumer products to a buyer (recipient) for resale <input type="checkbox"/>	\$		
		10 Crop insurance proceeds	\$		
		11	\$		
		12	\$		
		13 Excess golden parachute payments	\$		
		14 Gross proceeds paid to an attorney	\$		
15a Section 409A deferrals	15b Section 409A income	16 State tax withheld	\$	18 State income	
\$	\$	\$	\$	\$	

Form 1099-MISC 41-0852411 Department of the Treasury - Internal Revenue Service
 Do Not Cut or Separate Forms on This Page — Do Not Cut or Separate Forms on This Page

Past Employment Questions

- 3.** Did anyone in your household leave a job between **January 1, 2009 and today's date?**

For **each** job listed here, regardless of the amount of income received, you need to attach **one** of the following:

- a) Attach a letter from the employer on company letterhead Verifying your last day of employment.

OR

- b) Attach a copy of the last pay-stub from 2009 along with the matching 2009 W-2. The YTD amount on the pay-stub must match the wages shown on the W-2. (*Only valid for jobs left before December 1st, 2009*)

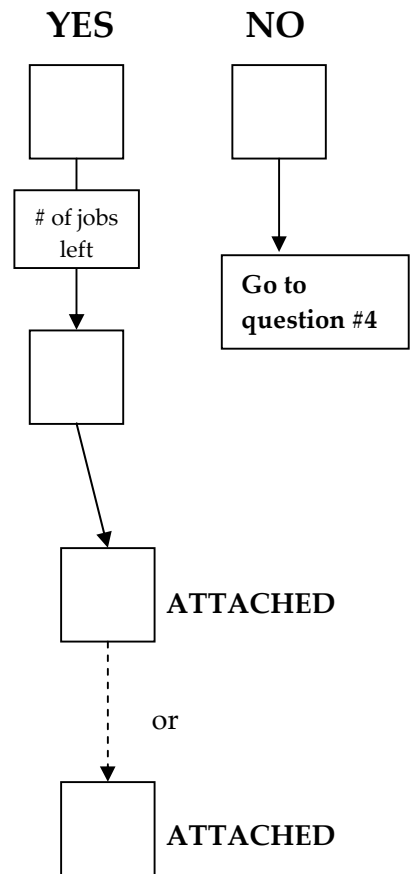

Self-Employment Questions

4. Is anyone in your household currently self-employed?

How many household members are self-employed?

For each self-employed job, complete the attached "Self-Employment Income Affidavit" in Section 3 in the back of this application. Be sure to include (all that apply):

- a) Copies of all most recent 1099s (should be 2009)
- b) A Copy of Schedule C for your most recent 1040s (should be 2009)
- c) Copies of current financial statements,
- d) Accountant's statements of Net Business Income
- e) Copies of income receipts
- f) Any other documentation you can provide to corroborate income.

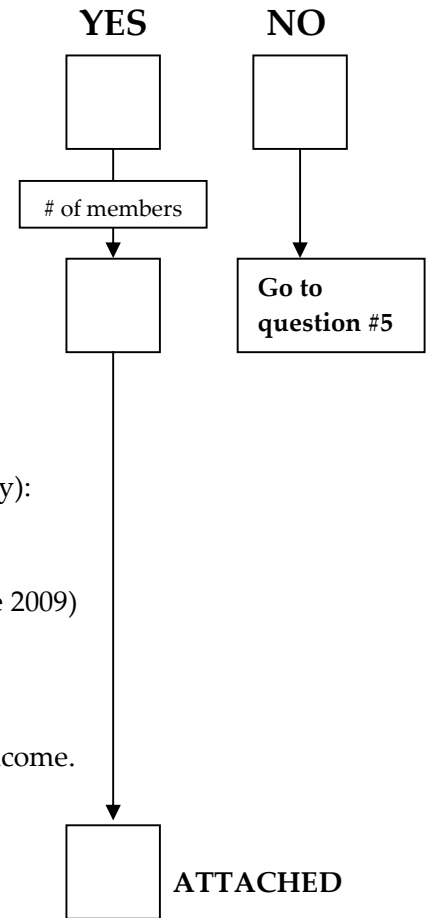

Household Members with No Income

5. Are there any household member over 18 years old that are claiming to currently make zero income?

How many household members over 18 years old are claiming to currently make zero income?

For each one of these household members, complete the "Certification of Zero Income" form attached in Section 3 in the back of this application.

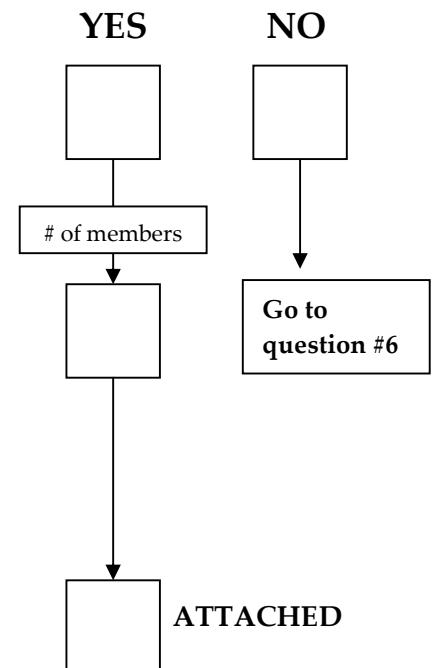

Child Support/Alimony Questions

- 6.** Are you currently receiving child support or alimony OR are you *legally* entitled to receive child support or alimony?

If you answered YES *and* you are receiving the amount you are entitled to receive, you will need to attach **one** of the following:

- a) A copy of your divorce decree or settlement agreement

OR

- b) A statement of payments from the Department of Revenue (DOR) *(if they have your payments on record)*

OR

- c) 3 detailed checking account statements that show Child Support/Alimony deposits

If you answered YES *but* you are NOT receiving the amount you are entitled to receive, you will need to attach:

- d) A copy of your divorce decree, proof a legal claim filed against the person that owes you money and, if applicable, statements from the DOR showing payments made *(If you do not show proof of a legal claim, it will be assumed you are receiving the full amount entitled when determining your eligibility)*

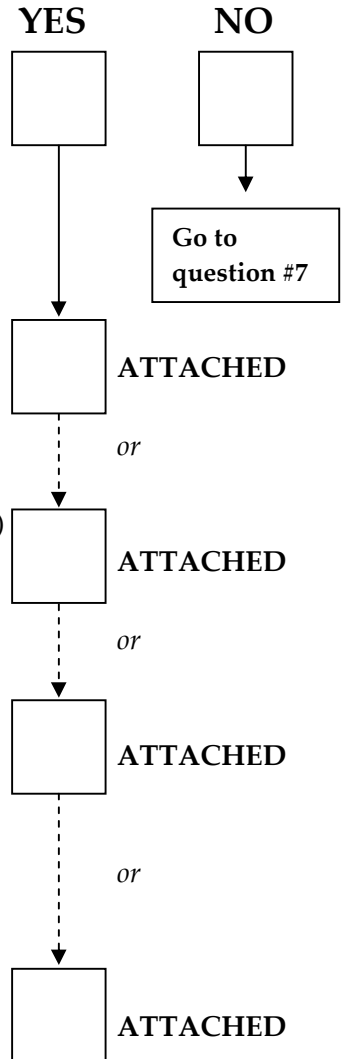

Divorce/Separation Questions

- 7.** Have you been divorced/separated since January 1st, 2006 or are you currently in the process of getting divorced/separated?

If you answered YES, you will need to attach:

- a) A copy of your divorce decree/separation agreement OR Proof that you have filed for divorce/separation.

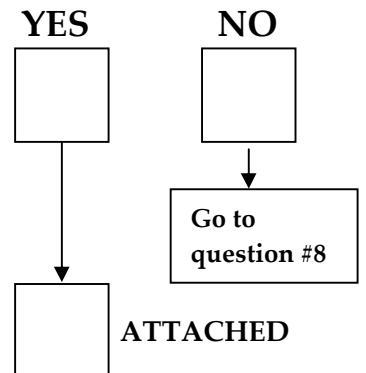

If you have not taken any legal action in filing for divorce or separation, you cannot apply as a single head-of-household. Your partner's income and assets will need to be included in your application.

Periodic Payment Questions

8. Did you list any sources under "Periodic Payments" on page 7? (i.e. payments from family members or recurring gifts)

How many sources did you list?

Please have your Contributor complete the "Recurring Gifts and Contributions Verification" form in Section 3 of this application. You can either attach the completed form with this application or have your Contributor mail it in.

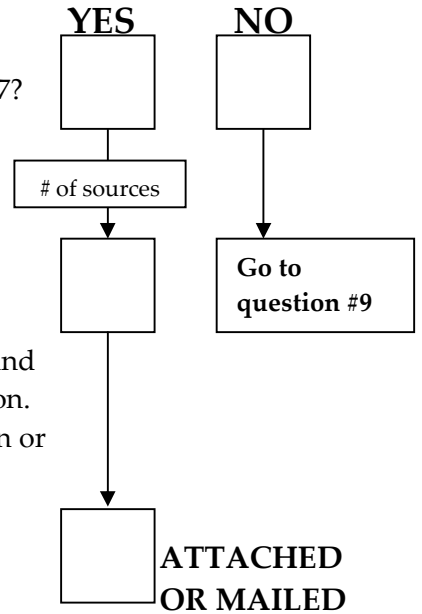

"Other Income" or Down Payment Assistance Questions

9. Did you list any sources under "Other Income" on page 7 of Section 1? **Any money a friend, family member or other source may use in helping you with your down payment or future housing costs must be noted here but will count towards your assets.**

How many sources did you list?

Please provide all necessary information to verify this source of Income and describe the source here:

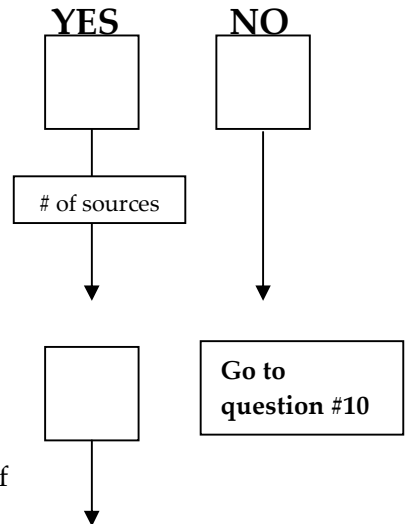

Asset Questions

- 10.** How many different Assets did you list on page 10?
(This includes Checking Accounts, Savings Accounts, Stocks, Bonds, **Net Cash Value of Retirement Accounts** etc.)

For **every** asset listed, REGARDLESS of the amount of money in the account (even just \$1), you need to:

- Attach copies of any of your most recent statements from the source of income (for checking accounts, attach **3** detailed statements)
- Attach any copies of 2009 1099s or end-of-year statements you may have received from the asset source.

of Assets



ATTACHED

Real Estate Questions

(Current Homeownership is only allowed for Elderly Households, Displaced Homemakers, or Single Parents)

- 11.** Do you currently own a home or property?

YES

NO

of properties

How many different properties/homes do you currently own?

Go to question #13

Are you **over the age of 55**?

YES

NO

For every property you need to submit all of the following:

- Attach a copy of a broker's opinion of the property
- Attach a statement from your lender showing your current balance on your mortgage or outstanding loans

YOU ARE NOT ELIGIBLE FOR ONE OF THESE AFFORDABLE UNITS

ATTACHED

Households with Students

12. Are any household members over 18 years old currently students or have been students in the past 12 months?

How many?

For each student you need to attach **School Transcripts** for the past 12 months.

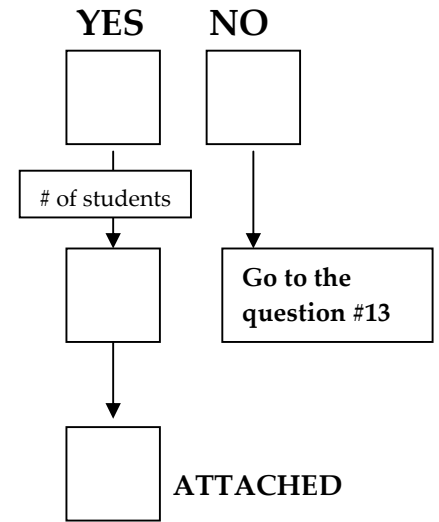

Mortgage Pre-Approval

of HOH

14. How many Heads-Of-Household (HOH) does your household have?

You must submit a mortgage pre-approval that follows the following standards.

- The loan must have a fixed interest rate through the full term of the mortgage.
- The loan must have a current fair market interest rate.
(No more than 2 percentage points above the current MassHousing rate)*
- The loan can have no more than two points.
- The buyer must provide a down payment of at least 3% - half of which must come from the buyer's own funds.
- The names of all Heads of Household must be on the Mortgage.

*MassHousing: (617) 854-1000 or www.masshousing.com

Your mortgage pre-approval must be for the minimum sales price of the largest unit size for which you are applying.

Ex: If you wish to apply for a 3BR unit but can only get pre-approved for \$168,600, then you cannot apply for the 3BR unit (priced approximately from \$172,400 to \$187,200). You can only apply for a 2BR or a 1BR unit.

Likewise, if you wish to apply for a 2BR unit but can only get pre-approved for \$148,000, then you can only apply for a 1BR unit.

You can go to any lender of your choosing as long as the pre-approvals abide by the above standards.

The best rate you can get on a mortgage will likely be through the soft-second mortgage program. The banks that offer this product that we recommend are:

Citizens Bank (Lynda D'Orlando 978-568-2480; Kate McGahan 617-354-6360)

Bank of America (Maria Mendoza 617-346-0534, Kurt Johnson 617-346-0534)

Marlborough Cooperative, a division of Butler Bank (Lindsey Egan 508-485-3000)

**PRE-APPROVAL
ATTACHED**

**You and Your Co-Applicant
Must Sign and Date the
Following Page**

**Again, if you have not filed your 2009 taxes, you
must ALSO provide all tax documentation from
2008 (1040s, 1099s, W-2s etc.)**

The information given in this application will be used to check that you are income qualified to be given an *opportunity* to purchase an affordable unit in the Town of Natick as part of this program. Entrance onto a Unit Selection List does not guarantee you a unit.

This development does not discriminate based on race, color, national origin, religion, sex, familial status, and handicap (disability).

THE UNDERSIGNED HEREBY CERTIFY THAT THE INFORMATION SET FORTH ABOVE IS TRUE AND CORRECT. THE UNDERSIGNED ACKNOWLEDGE THAT IF ANY OF THE INFORMATION ABOVE IS NOT TRUE AND ACCURATE THIS APPLICATION MAY BE REMOVED AT ANY POINT. THE UNDERSIGNED ACKNOWLEDGE THAT THE SALE OF THE UNIT TO BE OCCUPIED BY THE UNDERSIGNED MAY BE SUBJECT TO CANCELLATION IF ANY OF THE INFORMATION ABOVE IS NOT TRUE AND ACCURATE.

THE UNDERSIGNED GIVE CONSENT TO DHCD, THE TOWN OF NATICK AND SEB LLC TO VERIFY ALL INFORMATION PROVIDED IN THIS APPLICATION.

Applicant Signature

Date

Co-Applicant Signature

Date

Send applications with ALL required documentation to:

SEB

Re: NATICK GGP

165 Chestnut Hill Ave, Unit 2

Brighton, MA 02135

Remember, the deadline for the lottery has already passed. Eligible Households will now be added to the bottom of the appropriate lottery lists in the order that their completed applications are received. Please read the info packet for more details.

For Questions call (617) 782-6900 and leave a message.

Section 3

Additional Forms *(if applicable)*

**These are the forms that you only need to complete
if directed to do so in Section 2**

Verification of Terminated Employment

To Be Completed By Applicant:

Applicant/Tenant: _____

Soc. Security #: _____

Contact Info of previous employer:

Name of Contact					
Company Name					
Street Address					
City, State, Zip					
Tel. #		Fax #		email	

To Be Completed By Previous Employer:

Date of Termination: _____ Last Day Actually Worked: _____

Total Gross Income paid to employee over the last calendar year employed: _____

Reason for Termination: Employee Quit Other _____

Do you anticipate rehiring this employee? Yes No If yes, when: _____

Will the employee receive additional paychecks for Workman's Compensation? Yes No

If yes, provide the name and address of the company through which this can be verified:

Total severance pay anticipated for the next 12 months: _____

Is employee entitled to receive unemployment compensation? Yes No

AUTHORIZED SIGNATURE

Print Name: _____ Title: _____

Signature: _____ Date: _____

Telephone: _____

Please Fax form to SEB at (617) 576-6612 or mail to: SEB

Re: GGP Affordable Housing
165 Chestnut Hill Ave, Unit 2
Brighton, MA 02135

--OFFICE USE ONLY--

Date Sent: _____

Date Received: _____

Comments: _____

Self-Employment Income Affidavit

Anticipated Self-Employment earnings for this calendar year	\$
Previous year's Self-Employment income	\$

Please attach a current financial statement, accountant's statement of Net Business Income for this calendar year, income receipts, or any documentation you can provide to corroborate the income and earnings stated above.

Also attach a copy of last year's executed tax return including Schedule C.

CERTIFICATION

I certify that the above listed income amounts are accurate and I have provided all of the above requested information.

Signature :	
Print Name:	
Date:	

Certification of Zero Income

(To be completed by **adult** household members only, if appropriate)

Household Name: _____ Development Name: **GGP Natick
Affordable Housing**

1. I hereby certify that I have not received income from any of the following sources during the previous 12 months:
 - a. Wages from employment (including commissions, tips, bonuses, fees, etc.);
 - b. Income from operation of business;
 - c. Rental income from real or personal property;
 - d. Interest or dividends from assets;
 - e. Social Security payments, annuities, insurance policies, retirement funds, pensions, or death benefits;
 - f. Unemployment or disability payments;
 - g. Public assistance payments;
 - h. Periodic allowances such as alimony, child support, or gifts received from persons not living in my household;
 - i. Sales from self-employed resources (Avon, Mary Kay, Cutco, etc.);
 - j. Any other source not named above.

2. I will be using the following sources of funds to pay for rent and other necessities:

Under penalty of perjury, I certify that the information presented in this certification is true and accurate to the best of my knowledge. The undersigned further understand(s) that providing false representations herein constitutes an act of fraud. False, misleading or incomplete information may result in the termination of a lease agreement.

Signature of Applicant/Tenant

Printed Name of Applicant/Tenant

Date

Recurring Gifts and Contributions Verification

To Be Completed By Applicant:

Applicant/Tenant: _____
Soc. Security #: _____
Property Name: GGP Natick Affordable Housing
Address: Not Yet Determined
Natick, MA

To Be Completed By Contributor:

Please complete the following:

I, (Contributor's Name) _____,
contribute \$ _____ per _____ to the above named household
for the purpose of: _____

Non-Monetary Contributions:

I, (Contributor's Name) _____,

Contribute any of the following on a regular basis:

Gas for the car	\$ _____	Car Payments Directly to Bank	\$ _____
Alcohol	\$ _____	Utility Payments	\$ _____
Cigarettes	\$ _____	Clothing	\$ _____
Diapers	\$ _____	Other	\$ _____
Child Care Payments	\$ _____	NOTE: Food is excluded	

Print Name: _____ Signature: _____
Telephone: _____ Date: _____
Witnessed By: _____ Date: _____
Print Name: _____

Include this form with the Program Application, fax it to (617) 782-4500 or have the Contributor mail it to:

The Affordable Housing Lottery
Re: GGP Natick Affordable Housing
165 Chestnut Hill Ave, Unit 2
Brighton, MA 02135

--OFFICE USE ONLY--

Date Sent: _____ Date Received: _____
Comments: _____