

# Application

(Post-Lottery)

## The Lodge at Ames Pond Tewksbury, MA

Please complete a Lease Application at the Leasing Office prior to beginning this application. Their phone number is 978.851.1263.

**MAXIMUM Household Income Limits** (please see the Information Packet for more details): \$44,800 (1 person), \$51,200 (2 people), \$57,600 (3 people), \$64,000 (4 people), \$69,100 (5 people), and \$74,250 (6 people)

**Rents** are \$1,048\* (1 BR), \$1,245\* (2 BR) and \$1,433\* (3 BR) and do **not** include any utilities except water and sewer.

*\*This is not subsidized housing. The rents are set annually using a calculation that determines the "affordable" rent, which is based on the Area Median Incomes for the Lowell MSA. They are therefore subject to increase or decrease based on changes in Area Median Income and utility allowances. Rents do not change based on applicant's income; tenants will be responsible for paying the full rent themselves. Applicants with Section 8 Vouchers should contact their local housing authorities before applying.*

Please read the **Information Packet** for more details.

### Directions:

This application consists of three sections:

- 1) The Program Application
- 2) The Required Forms and Documentation Workbook
- 3) Additional Forms (if applicable)

The first two sections must be filled out entirely in order for your application to be processed. If a question does not apply to you, write "N/A" or cross it out. LEAVE NOTHING BLANK.

You must include all income and asset documentation with this application.

You must include all *applicable* forms from Section 3.

Send all applications to: **Affordable Housing Lottery**

**Re: Lodge at Ames Pond  
165 Chestnut Hill Ave #2  
Brighton, MA 02135**



For Questions call (617) 782-6900 and leave a message.

# **Section 1**

## **The Program Application**

## The Lodge at Ames Pond PROGRAM APPLICATION

Name \_\_\_\_\_ Home Tel. # \_\_\_\_\_

Address \_\_\_\_\_ Work Tel. # \_\_\_\_\_

City \_\_\_\_\_ State \_\_\_\_\_ Zip \_\_\_\_\_

Email (if available) \_\_\_\_\_

Unit size(s) for which you are applying (please circle):

1-Bedroom

2-Bedroom

3-Bedroom

### HOUSEHOLD MEMBERS:

Please list **ALL** household members who will occupy the affordable apartment:

Name	Date of Birth	Sex	SS#	Relationship

### HOUSEHOLD TYPE (please check one):

6 person household: all types

5 person household: all types

4 person household: all types

3 person household: 1 head-of-household plus 2 members

3 person household: 2 heads-of-household under criteria c (see pg. 11 of the **Information Packet**) plus member

3 person household: 2 heads-of-household plus 1 members

2 person household: 2 heads-of-household under criteria c (see pg. 11 of the **Info Packet**)

2 person household: 1 head-of-household plus one member

2 person household: 2 heads-of-household

1 person household: all types

**Section 8 (circle yes or no):**

Do you currently have a Section 8 Voucher (or similar housing subsidy)?    **YES**                      **NO**

**PREFERENCE INFORMATION**

You are requested to complete the following **optional** section in order to assist in determining preference. Completing this section may qualify you for additional lottery pools. (Please check all boxes that apply):

	APPLICANT	CO-APPLICANT	DEPENDENT
<b>Black</b>			
<b>Hispanic</b>			
<b>Cape Verdean</b>			
<b>Asian/Pacific Islander</b>			
<b>Eskimo/Aleut</b>			
<b>Native American</b>			
<b>White/Non-Minority</b>			

For **Disabled-Accessible Preference**, check the appropriate box for the following question:

	YES	NO
Are you, or any member of your household, in need of an accessible unit? (This is defined as persons with a physical or mental disability that meet standards established by the Department of Housing and Community Development and state laws for disabled housing) <i>Verification of need of an accessible unit must be provided in the form of a doctor's note or equivalent.</i>		

**DATABASE INFORMATION**

How did you find out about this affordable housing opportunity?  
(write your answer in the space provided and please be as specific as possible)

## **Instructions for Completing the Following Income Table**

- List ALL CURRENT sources of income as requested below for ALL household members over 18 years old.
- Please note that the Income Table is 2 pages and income from Social Security, Pension, interest etc. is all on the second page of the table.
- If you have left a job since January 1, 2010 and are no longer receiving income, do NOT list it in this table.
- For self-employed applicants- include the employer, contract or job name in the space provided.
- “Interest Income” refers to any amount that you receive from any asset including amounts that you may be drawing down from a retirement account or 401K.
- For any section that doesn’t apply, cross out or write NA.

**In Section 2 of this application, you will be asked multiple questions about your information in the following Income and Asset tables.**

## INCOME

Household Member Name	Source of Income	Current GROSS Monthly Income
	Employer (name)	
	Employer (name)	
	Employer (name)	
	Employer (name)	
	Employer (name)	
	Employer (name)	
	Employer (name)	
	Employer (name)	
	Employer (name)	
	Employer (name)	
	Self-Employed (source name)	
	Self-Employed (source name)	
	Self-Employed (source name)	
	Self-Employed (source name)	
	Child Support/Alimony	
	Child Support/Alimony	
	Periodic payments from family/friends <i>(i.e. rent assistance from family)</i>	
	Periodic payments from family/friends <i>(i.e. rent assistance from family)</i>	
	Other Income (name/source)	

Household Member Name	Source of Income	Current GROSS Monthly Income
	Social Security	
	Social Security	
	Social Security	
	Social Security	
	SSDI	
	SSDI	
	Unemployment Compensation	
	Workman's Compensation	
	Severance Pay	
	Pension (list source)	
	Pension (list source)	
	Retirement Funds	
	Title IV/TANF	
	Full-Time Student Income (18 & Over Only)	
	Full-Time Student Income (18 & Over Only)	
	Interest Income (source)	
	Interest Income (source)	
	Interest Income (source)	
	Interest Income (source)	
	Interest Income (source)	
	Interest Income (source)	
	Total Gross Monthly Household Income (TGMHI)	\$ /month
<b>TGMHI x 12 = Anticipated Gross Yearly Household Income \$ /year</b>		

ANTICIPATED CHANGES IN INCOME (please check one)	YES	NO
<p>1. Is your Anticipated Gross Yearly Household Income (written in the last box at the end of the above Income Table) <b><i>greater than the Allowable Income Limits</i></b> for a household of your size as specified on the cover page of this Program Application?</p> <p>If <b>YES</b>, please explain why you think your household is still eligible for entrance into this Lottery (<i>ex: upcoming maternity leave, planned change in employment etc.</i>):</p> <p><i>All claims made above must be supported with documentation submitted with this application.</i></p>		
<p>2. Are there any planned changes in income over the next 12 months?</p> <p>If <b>YES</b>, please explain:</p> <p><i>All claims made above must be supported with documentation submitted with this application.</i></p>		

## ASSETS

If a section doesn't apply, cross out or write NA. You will need to submit detailed bank/balance statements for EVERY ASSET listed here.

Checking Accounts	Name on Account	Bank	Amount	
			Balance	\$
			Balance	\$
			Balance	\$
Savings Accounts			Balance	\$
			Balance	\$
			Balance	\$
			Balance	\$
Trust Account			Balance	\$
Certificates (or CDs)			Balance	\$
			Balance	\$
			Balance	\$
			Balance	\$
Savings Bonds	Maturity Date:		Value	\$
	Maturity Date:		Value	\$
401k, IRA, Retirement Accounts (Net Cash Value)	Company Name:		Value	\$
	Company Name:		Value	\$
	Company Name:		Value	\$
	Company Name:		Value	\$
Mutual Funds	Name:	# of Shares:	Interest/Dividends	Value
			\$	\$
			\$	\$
			\$	\$
Stocks			\$	\$
			\$	\$
			\$	\$
Bonds			\$	\$
			\$	\$
Investment Property			Appraised Value	\$

## REAL ESTATE

Do you, or anyone on this application, own any property or have owned property in the past 2 years? <i>(You may currently own property but it must be sold before your move-in date.)</i>	<input type="checkbox"/> Yes <input type="checkbox"/> No
Are you, or anyone on this application, entitled to receive any amount of money from the sale of any property? (currently or thru an upcoming court settlement)	<input type="checkbox"/> Yes <input type="checkbox"/> No
<b><i>If yes to either question, type of property:</i></b>	
Location of property:	\$
Appraised Market Value:	\$
Mortgage or outstanding loans balance due:	\$

# **Section 2**

# **The Required**

# **Forms and**

# **Documentation**

# **Worksheet**

Please answer each of the following 15 questions, attach all requested documentation, complete all applicable forms, and check all applicable boxes.

**Every time you answer “YES”, you MUST submit the requested documentation.**

**If you have not yet received your 2009 W-2s, 1099s, or 1040s, please make a note of it and send in these documents from 2008.**

Only send copies of income/asset documentation.  
We do not want originals.

## Current Employment Questions

1. Is anyone in your household currently employed?  
(NOT including self-employment)

How many of the jobs on page 6 of the Program Application are currently being worked? (NOT including self-employment)

For **every** job listed here you need attach BOTH:

- Copies of the 5 most recent pay-stubs  
(If you do not receive pay-stubs you will need to attach a note from the employer on company letterhead stating your tenure and Year To Date amount)
- Attach copies of all your 2009 W-2s  
(if a job was started after January 1, 2009, write NA)

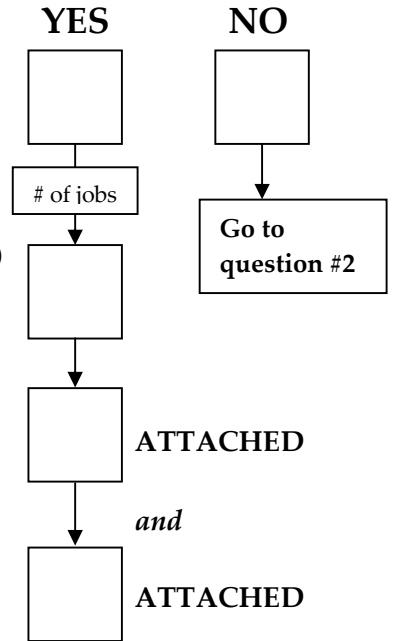

Example of a pay-stub:

Employee Name		SS#	Period End	Check Date	Check No.	Check Amount	
Bbbbbbb.Bbbbbbb B		111-66-7777	10/23/99	11/03/99	208	*****515.40	
Description	Hours	Rate of Pay	Earnings	Deductions	Current	Y-T-D	Leave Balance
Reg Pay	8.00	13.65	81.90	Fed Tax	66.39	1,830.67	
Vacation	28.00	13.65	382.20	FICA SS	40.32	985.59	
Ben Bank	1.00	90.08	90.08	FICA Med	9.43	230.50	VACATION 41.24
Misc	7.00	13.65	95.55	PA ST TX	18.19	445.06	
				Sweat Tax	.00	10.00	
Description	Current	Y-T-D					
GROSS PAY	649.73	15,895.44					
TOTAL DEDUCTIONS	134.33						
NET PAY	515.40						

SWARTHMORE COLLEGE - Swarthmore, PA. 19081

Example of a blank W-2 (these are provided by your employer for your taxes):

a Control number		22222	Void <input type="checkbox"/>		For Official Use Only ▶ OMB No. 1545-0046	
b Employer identification number (EIN)			1 Wages, tips, other compensation		2 Federal income tax withheld	
c Employer's name, address, and ZIP code			3 Social security wages		4 Social security tax withheld	
			5 Medicare wages and tips		6 Medicare tax withheld	
			7 Social security tips		8 Allocated tips	
d Employer's social security number			9 Advance EIC payment		10 Dependent care benefits	
e Employer's first name and initial		Last name	11 Nonqualified plans		12a See instructions for box 12	
			13a State employee retirement plan		12b	
			13b		12c	
			14 Other		12d	
f Employer's address and ZIP code						
16 State	16 State wages, tips, etc.	17 State income tax	18 Local wages, tips, etc.	19 Local income tax	20 Locality name	

Form **W-2** Wage and Tax Statement **2006** Department of the Treasury—Internal Revenue Service  
 Copy A For Social Security Administration — Send this entire page with Form W-3 to the Social Security Administration; photocopies are not acceptable. Copy D For Privacy Act and Paperwork Reduction Act Notices, see back of Copy D. Ca. No. 10134D

Do Not Cut, Fold, or Staple Forms on This Page — Do Not Cut, Fold, or Staple Forms on This Page

## Income Questions

2. Did you list any sources of Income on page 7 of this application?  
*(ie: Social Security, SSDI, Pensions, Unemployment, Public Assistance, TANF, Veteran's Benefits, Retirement, Student Income, Interest Income etc.)*

YES

NO



# of sources

How many sources of Income did you list on page 7?

Go to question #3

For **every** source of income listed, regardless of the amount of income received (even just \$1), you need to:

- Attach copies of your most recent statements from the source of income.
- Attach copies of all 2009 1099s from the source of income *(if received)*.

***If you do not receive statements*** (i.e. the amounts are direct deposited), please submit 3 months checking account statements and highlight the appropriate deposits.

ATTACHED

*Example of a blank 1099:*

9595		<input type="checkbox"/> VOID <input type="checkbox"/> CORRECTED		OMB No. 1545-0115	
PAYER'S name, street address, city, state, ZIP code, and telephone no.		1 Rents	\$	2006	Miscellaneous Income
		2 Royalties	\$	Form 1099-MISC	
		3 Other income	\$	4 Federal income tax withheld	Copy A
PAYER'S federal identification number	RECIPIENT'S identification number	5 Fishing boat proceeds	\$	6 Medical and health care payments	For Internal Revenue Service Center
RECIPIENT'S name		7 Nonemployee compensation	\$	8 Substitute payments in lieu of dividends or interest	File with Form 1098.
Street address (including apt. no.)		9 Payer made direct sales of \$5,000 or more of consumer products to a buyer (recipient) for resale <input type="checkbox"/>	\$	10 Crop insurance proceeds	For Privacy Act and Paperwork Reduction Act Notice, see the 2006 General Instructions for Forms 1099, 1098, 5498, and W-2G.
City, state, and ZIP code		11	\$	12	
Account number (see instructions)	2nd TIN not <input type="checkbox"/>	13 Excess golden parachute payments	\$	14 Gross proceeds paid to an attorney	
15a Section 409A deferrals	15b Section 409A income	16 State tax withheld	\$	17 State/Payer's state no.	18 State income
\$	\$	\$	\$	\$	\$

Form 1099-MISC 41-0852411 Department of the Treasury - Internal Revenue Service  
 Do Not Cut or Separate Forms on This Page — Do Not Cut or Separate Forms on This Page

### Past Employment Questions

3. Did anyone in your household leave a job between January 1, 2008 and today's date?

For **each** job listed here, regardless of the amount of income received, you need to attach **one** of the following:

- a) Attach a letter from the employer on company letterhead Verifying your last day of employment.

OR

- b) Attach a copy of the last pay-stub from 2008 or 2009 along with the matching 2008 or 2009 W-2. The YTD amount on the pay-stub must match the wages shown on the W-2. *(Only valid for jobs left before December 1<sup>st</sup>, 2009)*

OR

- c) Complete the "Verification of Terminated Employment" attached on the back of this application in Section 3. Once we have received the form, we will send this form to the previous employer. Verification normally takes an additional 1-2 weeks. Employers may not send these forms back- in which case, you will need to submit 3a or 3b (from above). If you choose to use the attached form *only fill in the top section of the form! The bottom section must be completed and signed by an authorized company official.*

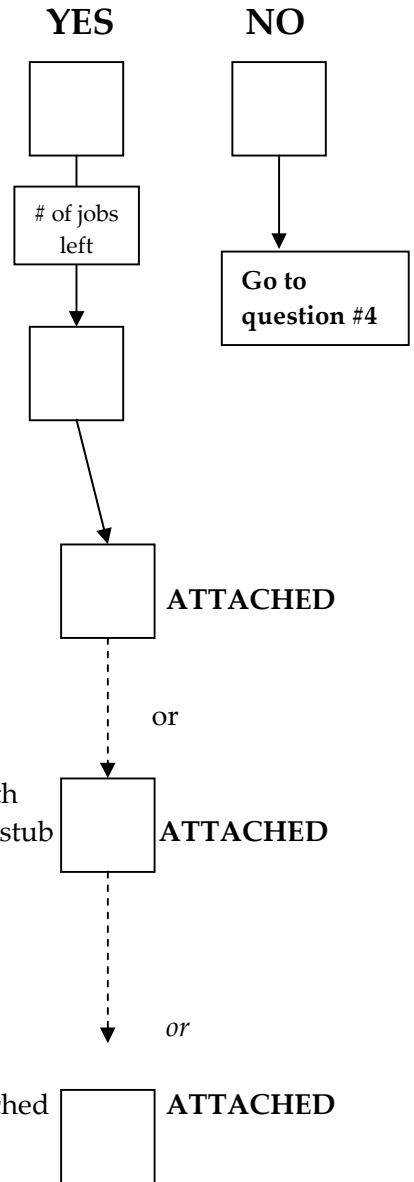

## Self-Employment Questions

- 4.** Is anyone in your household currently self-employed?

How many household members are self-employed?

For each self-employed job, complete the attached "Self-Employment Income Affidavit" in the back of this application. Be sure to include (all that apply):

- a) Copies of all 2009 1099s (*or most recent*)
- b) A Copy of Schedule C of your 2009 1040s (*or most recent*)
- c) Copies of current financial statements,
- d) Accountant's statements of Net Business Income
- e) Copies of income receipts
- f) Any other documentation you can provide to corroborate income.

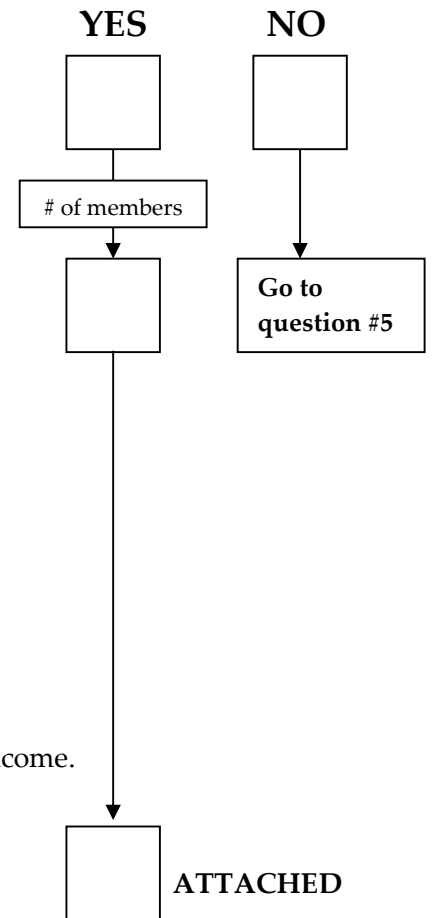

## Household Members with No Income

- 5.** Are there any household member over 18 years old that are claiming to currently make zero income?

How many household members over 18 years old are claiming to currently make zero income?

For each one of these household members, complete the "Certification of Zero Income" form attached in the back of this application.

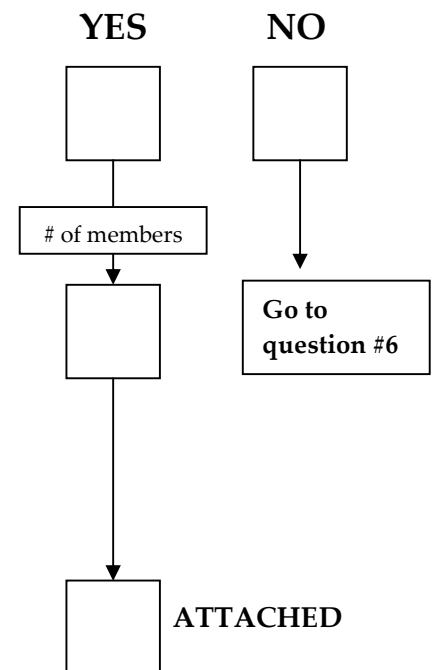

## Child Support/Alimony Questions

- 6.** Are you currently receiving child support or alimony OR are you *legally* entitled to receive child support or alimony?

If you answered YES *and* you are receiving the amount you are entitled to receive, you will need to attach **one** of the following:

- a) A copy of your divorce decree or settlement agreement

OR

- b) A statement of payments from the Department of Revenue (DOR) *(if they have your payments on record)*

OR

- c) 3 detailed checking account statements that show Child Support/Alimony deposits

If you answered YES *but* you are NOT receiving the amount you are entitled to receive, you will need to attach:

- d) A copy of your divorce decree, proof a legal claim filed against the person that owes you money and, if applicable, statements from the DOR showing payments made *(If you do not show proof of a legal claim, it will be assumed you are receiving the full amount entitled when determining your eligibility)*

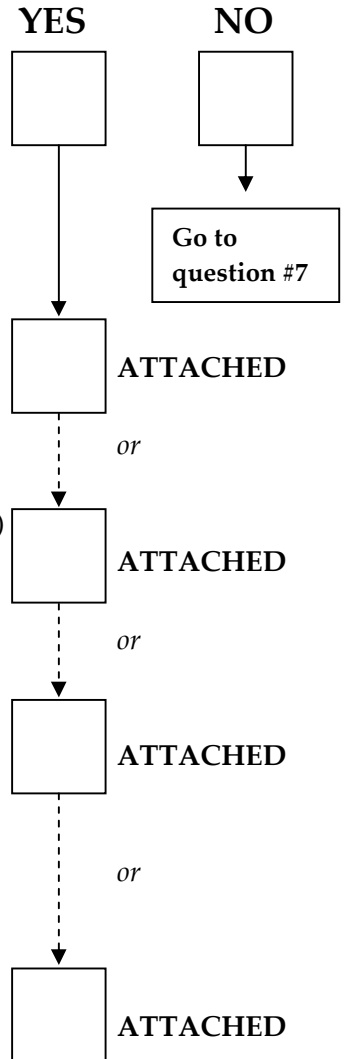

## Divorce/Separation Questions

- 7.** Have you been divorced/separated since January 1<sup>st</sup>, 2009 or are you currently in the process of getting divorced/separated?

If you answered YES, you will need to attach:

- a) A copy of your divorce decree/separation agreement OR Proof that you have filed for divorce/separation.

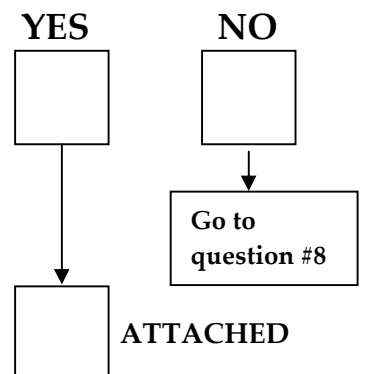

*If you have not taken any legal action in filing for divorce or separation, you cannot apply as a single head-of-household. Your partner's income and assets will need to be included in your application.*

## Periodic Payment Questions

8. Did you list any sources under "Periodic Payments" on page 6? (i.e. rental assistance from family members or recurring gifts)

YES

NO

# of sources

How many sources did you list?

Go to question #9

Please have your Contributor complete the "Recurring Gifts and Contributions Verification" form in the back of this application. You can either attach the completed form with this application or have your Contributor mail it in.

ATTACHED OR MAILED

## "Other Income" Questions

9. Did you list any sources under "Other Income" on page 6 of Section 1?

YES

NO

# of sources

How many sources did you list?

Go to question #10

Please provide all necessary information to verify this source of Income and describe the source here:

## Asset Questions

- 10.** How many different Assets did you list on page 9?  
 (This includes **Net Cash Value of Retirement Accounts**, *i.e.* the value of your Retirement Account after penalties if you were to withdraw all funds today, Checking Accounts, Savings Accounts, Stocks, Bonds etc.)

For **every** asset listed, REGARDLESS of the amount of money in the account (even just \$1), you need to:

- Attach copies of any of your most recent statements from the source of income (for checking accounts, attach 3 detailed statements)
- Attach any copies of 2008 1099s or end-of-year statements you may have received from the asset source.

# of Assets

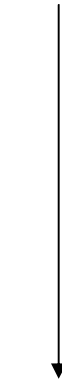

ATTACHED

## Real Estate Questions

- 11.** Do you currently own a home or property?  
 (Property must be sold prior to move-in)

How many different properties/homes do you currently own?

**For property that will be sold prior to move-in:**

- Attach a copy of a broker's opinion of the property (or a P&S Agreement)
- Attach a statement from your lender showing your current balance on your mortgage or outstanding loans

**For property you will lose through a divorce:**

- Attach legal divorce or separation documentation showing that you will no longer be on the mortgage or deed to your house.

A note from your lawyer is not a sufficient replacement for the above.

**For property that will be lost through foreclosure:**

- Attach your notice of foreclosure along with the date on which the home will be foreclosed.
- Attach statements from your lender showing your delinquent payments

YES NO



# of properties



Go to question #12





ATTACHED

## Section 8 Questions

- 12.** Are you a Section 8 certificate holder or holder of a housing voucher from a subsidized housing program?

If YES, please **attach a copy of your Section 8 Voucher here.**  
(You can get this from your local Housing Authority)

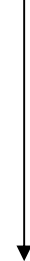
YES



ATTACHED

NO



Go to  
question #13

## Households with Students

- 13.** Are any household members over 18 years old are currently students or have been students in the past 12 months?

How many?

For each student you need to attach **School Transcripts** for the past 12 months.

YES

# of students



ATTACHED

NO



Go to the  
question #14

## Households with a member with a Disability

**14.** Is anyone in your household applying as a person that falls under any one of the following 2 categories?

- 1.) In need of a Disabled-Accessible Unit *or*
- 2.) Shall not be required to share a bedroom as the consequence of sharing would be a severe adverse impact on his or her mental or physical health?

**YES**



**ATTACHED**

**NO**



**Go to the  
question #16**

# 1040 Tax Transcripts for 2009 (or most recent)

# of members

15. How many members are in your Household?

EVERY one of your household members should be listed on a 1040 Tax Transcript (unless they were not yet born). You need to provide the Tax Transcripts for your most recent taxes filed. **These should be your 2009 1040s.** Be sure to send in every page!

**Do NOT send in a copy filled out by hand.** If you had a professional prepare your taxes, they will have the transcripts you need. You can also call the IRS at (800) 829-1040 and they can mail or fax you a copy of any of these transcripts.

For each household member that has not filed Taxes nor been on a Tax Transcript for any of the last few years, unless they were not yet born you must submit a Statement from the IRS showing "NO RECORD" of filing. Please call (800) 829-1040 to request a statement. Only if a member has not filed for approx. 5+ years, will the IRS not be able to provide a statement.

If a household member moved to this country in the past 3 years and does not have 3 years of tax transcripts, you need to also submit proof of his date of immigration.

ALL 1040s ATTACHED

Example of a blank 1040. The 1040s you send in must be complete and computer generated. Do not send in the form you filled out by hand!

Form 1040		Department of the Treasury—Internal Revenue Service		2005		OMB No. 1545-0047	
Your first name and initial		Last name		Your social security number			
If a joint return, spouse's first name and initial		Last name		Spouse's social security number			
Home address (number and street). If you have a P.O. box, see page 10.		Apt. no.		City, town or post office, state, and ZIP code. If you have a foreign address, see page 10.		You must enter your SSN(s) above.	
Filing Status		Exemptions		Income		Adjusted Gross Income	
<input type="checkbox"/> Single <input type="checkbox"/> Married filing jointly (even if only one had income) <input type="checkbox"/> Married filing separately. Enter spouse's SSN above and full name here.		<input type="checkbox"/> Yourself. If someone can claim you as a dependent, do not check box 9a. <input type="checkbox"/> Spouse <input type="checkbox"/> Dependent (1) First name Last name (2) Dependent's social security number (3) Dependent's relationship to you (4) If filing with you (see page 17)		7 Wages, salaries, tips, etc. Attach Form(s) W-2 8a Taxable interest. Attach Schedule B if required 8b Tax-exempt interest. Do not include on line 8a 9a Ordinary dividends. Attach Schedule B if required 9b Qualified dividends (see page 23) 10 Taxable refunds, credits, or offsets of state and local income taxes (see page 29) 11 Alimony received 12 Business income or (loss). Attach Schedule C or C-EZ 13 Capital gain or (loss). Attach Schedule D if required. If not required, check here 14 Other gains or (losses). Attach Form 4797 15a IRA distributions (1) 15a (2) Taxable amount (see page 25) 15b Pensions and annuities (1) 15a (2) Taxable amount (see page 25) 16a Rental real estate, royalties, partnerships, S corporations, trusts, etc. Attach Schedule E 16b Farm income or (loss). Attach Schedule F 17 Unemployment compensation 18 Social security benefits (1) 18a (2) Taxable amount (see page 27) 19 Other income. List type and amount (see page 29) 20 Add the amounts in the far right column for lines 7 through 21. This is your total income		21 Add the amounts in the far right column for lines 7 through 21. This is your total income 22 Add the amounts in the far right column for lines 7 through 21. This is your total income 23 Educator expenses (see page 29) 24 Certain business expenses of reservists, performing artists, and fee-basis government officials. Attach Form 2106 or 2106-EZ 25 Health savings account deduction. Attach Form 8889 26 Moving expenses. Attach Form 3903 27 One-half of self-employment tax. Attach Schedule SE 28 Self-employed SEP, SIMPLE, and qualified plans 29 Self-employed health insurance deduction (see page 30) 30 Penalty on early withdrawal of savings 31a Alimony paid b Recipient's SSN 32 IRA deduction (see page 31) 33 Student loan interest deduction (see page 33) 34 Tuition and fees deduction (see page 34) 35 Domestic production activities deduction. Attach Form 8803 36 Add line 23 through 31a and 32 through 35 37 Subtract line 36 from line 22. This is your adjusted gross income	

**You and Your Co-Applicant  
Must Sign and Date the  
Following Page**

**And again, if you have not filed your 2009 taxes, you  
must ALSO provide all tax documentation from  
2008 (1040s, 1099s, W-2s etc.)**

The information given in this application will be used to check that you are income qualified to be given an *opportunity* to lease an affordable unit in the Town of Tewksbury as part of this program.

**THIS IS NOT A LEASE APPLICATION.**

THE UNDERSIGNED HEREBY CERTIFY THAT THE INFORMATION SET FORTH ABOVE IS TRUE AND CORRECT. THE UNDERSIGNED ACKNOWLEDGE THAT IF ANY OF THE INFORMATION ABOVE IS NOT TRUE AND ACCURATE THIS APPLICATION MAY BE REMOVED AT ANY POINT. THE UNDERSIGNED ACKNOWLEDGE THAT THE LEASE OR RESIDENCY AGREEMENT FOR THE UNIT TO BE OCCUPIED BY THE UNDERSIGNED MAY BE SUBJECT TO CANCELLATION IF ANY OF THE INFORMATION ABOVE IS NOT TRUE AND ACCURATE.

THE UNDERSIGNED GIVE CONSENT TO DHCD, THE TOWN OF TEWKSBURY AND SEB LLC TO VERIFY ALL INFORMATION PROVIDED IN THIS APPLICATION.

THE UNDERSIGNED AUTHORIZE THE RELEASE OF INFORMATION NECESSARY IN DETERMING INCOME AND ASSETS FROM THIRD-PARTY REFERENCES.

\_\_\_\_\_  
Applicant Signature

\_\_\_\_\_  
Date

\_\_\_\_\_  
Co-Applicant Signature

\_\_\_\_\_  
Date

**Send applications with ALL required documentation to:**

**Affordable Housing Lottery  
Re: The Lodge at Ames Pond  
165 Chestnut Hill Ave #2  
Brighton, MA 02135**

**For Questions call (617) 782-6900 and leave a message.**

# **Section 3**

## **Additional Forms** *(if applicable)*

**These are the forms that you only need to complete  
if directed to do so in Section 2**

# Verification of Terminated Employment

---

**To Be Completed By Applicant:**

**Applicant/Tenant:** \_\_\_\_\_

**Soc. Security #:** \_\_\_\_\_

Contact Info of previous employer:

Name of Contact					
Company Name					
Street Address					
Town, State, Zip					
Tel. #		Fax #		email	

---

**To Be Completed By Previous Employer:**

Date of Termination: \_\_\_\_\_ Last Day Actually Worked: \_\_\_\_\_

Total Gross Income paid to employee over the last calendar year employed: \_\_\_\_\_

Reason for Termination:     Employee Quit     Other \_\_\_\_\_

Do you anticipate rehiring this employee?     Yes     No    If yes, when: \_\_\_\_\_

Will the employee receive additional paychecks for Workman's Compensation?     Yes     No

If yes, provide the name and address of the company through which this can be verified:

\_\_\_\_\_

\_\_\_\_\_

Total severance pay anticipated for the next 12 months: \_\_\_\_\_

Is employee entitled to receive unemployment compensation?     Yes     No

### AUTHORIZED SIGNATURE

Print Name: \_\_\_\_\_ Title: \_\_\_\_\_

Signature: \_\_\_\_\_ Date: \_\_\_\_\_

Telephone: \_\_\_\_\_

Please Fax form to SEB at (617) 782-4500 or mail to:    SEB

Re: The Lodge at Ames Pond

165 Chestnut Hill Ave #2

Brighton, MA 02135

---

**--OFFICE USE ONLY--**

Date Sent: \_\_\_\_\_

Date Received: \_\_\_\_\_

Comments: \_\_\_\_\_



# Self-Employment Income Affidavit

Anticipated Self-Employment earnings for this calendar year	\$
Previous year's Self-Employment income	\$

Please attach a current financial statement, accountant's statement of Net Business Income for this calendar year, income receipts, or any documentation you can provide to corroborate the income and earnings stated above.

Also attach a copy of last year's executed tax return including Schedule C.

## CERTIFICATION

I certify that the above listed income amounts are accurate and I have provided all of the above requested information.

Signature :	
Print Name:	
Date:	



# Certification of Zero Income

(To be completed by **adult** household members only, if appropriate)

Household Name: \_\_\_\_\_ Development Name: \_\_\_\_\_

1. I hereby certify that I have not received income from any of the following sources during the previous 12 months:
  - a. Wages from employment (including commissions, tips, bonuses, fees, etc.);
  - b. Income from operation of business;
  - c. Rental income from real or personal property;
  - d. Interest or dividends from assets;
  - e. Social Security payments, annuities, insurance policies, retirement funds, pensions, or death benefits;
  - f. Unemployment or disability payments;
  - g. Public assistance payments;
  - h. Periodic allowances such as alimony, child support, or gifts received from persons not living in my household;
  - i. Sales from self-employed resources (Avon, Mary Kay, Cutco, etc.);
  - j. Any other source not named above.
  
2. I will be using the following sources of funds to pay for rent and other necessities:  
\_\_\_\_\_  
\_\_\_\_\_

Under penalty of perjury, I certify that the information presented in this certification is true and accurate to the best of my knowledge. The undersigned further understand(s) that providing false representations herein constitutes an act of fraud. False, misleading or incomplete information may result in the termination of a lease agreement.

\_\_\_\_\_  
Signature of Applicant/Tenant

\_\_\_\_\_  
Printed Name of Applicant/Tenant

\_\_\_\_\_  
Date



# Recurring Gifts and Contributions Verification

---

## To Be Completed By Applicant:

Applicant/Tenant: \_\_\_\_\_  
Soc. Security #: \_\_\_\_\_  
Property Name: The Lodge at Ames Pond  
Address: Ames Pond Drive  
Tewksbury, MA

---

## To Be Completed By Contributor:

Please complete the following:

I, (Contributor's Name) \_\_\_\_\_,  
contribute \$ \_\_\_\_\_ per \_\_\_\_\_ to the above named household  
for the purpose of: \_\_\_\_\_

### Non-Monetary Contributions:

I, (Contributor's Name) \_\_\_\_\_

Contribute any of the following on a regular basis:

Gas for the car	\$ _____	Car Payments Directly to Bank	\$ _____
Alcohol	\$ _____	Utility Payments	\$ _____
Cigarettes	\$ _____	Clothing	\$ _____
Diapers	\$ _____	Other	\$ _____
Child Care Payments	\$ _____	<b>NOTE: Food is excluded</b>	

Print Name: \_\_\_\_\_ Signature: \_\_\_\_\_  
Telephone: \_\_\_\_\_ Date: \_\_\_\_\_  
Witnessed By: \_\_\_\_\_ Date: \_\_\_\_\_  
Print Name: \_\_\_\_\_

**Include this form with the Program Application, fax it to (617) 782-4500 or have the**

**Contributor mail it to:** The Affordable Housing Lottery  
Re: The Lodge at Ames Pond  
165 Chestnut Hill Ave #2  
Brighton, MA 02315

---

**--OFFICE USE ONLY--**

---

Date Sent: \_\_\_\_\_ Date Received: \_\_\_\_\_

Comments: